

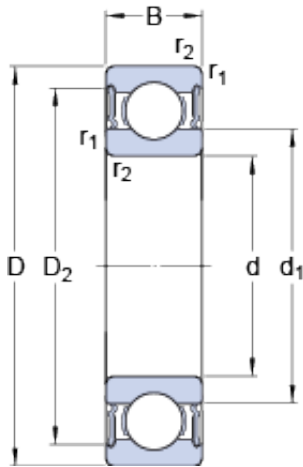

China abec 5 Bearing Supplier



6206-2RS1 Bearing 2D drawings and 3D CAD models

Deep groove ball bearing 6206-2RS1 skf bearing list

Bearing No. 6206-2RS1

Size	62x30x16 mm
Bore Diameter	62 mm
Outer Diameter	30 mm
Width	16 mm
d	30 mm
D	62 mm
B	16 mm
d ₁	40.36 mm
D ₂	54.06 mm
r _{1,2} - min.	1 mm
d _a - min.	35.6 mm
d _a - max.	40.3 mm
D _a - max.	56.4 mm
r _a - max.	1 mm
Basic dynamic load rating - C	20.3 kN
Basic static load rating - C ₀	11.2 kN
Fatigue load limit - P _u	0.475 kN
Limiting speed	7500 r/min
Calculation factor - k _r	0.025
Calculation factor - f ₀	14
Category	Single Row Ball Bearings
Inventory	2.0
Manufacturer Name	SKF
Minimum Buy Quantity	N/A



China abec 5 Bearing Supplier

Weight / Kilogram	0.209
EAN	7316577758774
Product Group	B00308
Enclosure	2 Seals
Precision Class	ABEC 1 ISO P0
Maximum Capacity / Filling Slot	No
Rolling Element	Ball Bearing
Snap Ring	No
Internal Special Features	No
Cage Material	Steel
Enclosure Type	Contact Seal
Internal Clearance	C0-Medium
Inch - Metric	Metric
Long Description	30MM Bore; 62MM Outside Diameter; 16MM Outer Race Diameter; 2 Seals; Ball Bearing; ABEC 1 ISO P0; No Filling Slot; No Snap Ring; No Internal Special Features
Category	Single Row Ball Bearing
UNSPSC	31171504
Harmonized Tariff Code	8482.10.50.68
Noun	Bearing
Keyword String	Ball
Manufacturer URL	http://www.skf.com
Manufacturer Item Number	6206-2RS1
Weight / LBS	0.461
Outer Race Width	0.63 Inch 16 Millimeter
Outside Diameter	2.441 Inch 62 Millimeter
Bore	1.181 Inch 30 Millimeter
bore diameter:	30 mm
static load capacity:	11.2 kN



China abec 5 Bearing Supplier

outside diameter:	62 mm
precision rating:	Not Rated
overall width:	16 mm
finish/coating:	Uncoated
bore type:	Round
cage material:	Steel
closure type:	Double Sealed
outer ring width:	16 mm
row type & fill slot:	Single Row Non-Fill Slot
fillet radius:	1 mm
internal clearance:	C0
maximum rpm:	7500 RPM
operating temperature range:	-40 to +210 ° F
series:	6200
dynamic load capacity:	20.3 kN
d_1	40.36 mm
D_2	54.06 mm
d_a min.	35.6 mm
d_a max.	40.3 mm
D_a max.	56.4 mm
r_a max.	1 mm
Basic dynamic load rating C	20.3 kN
Basic static load rating C_0	11.2 kN
Fatigue load limit P_u	0.475 kN
Calculation factor k_r	0.025
Calculation factor f_0	14
Mass bearing	0.21 kg